

FOR LEASE

# Huron St. Building

Suite 46 46-54 N. Huron St. Ypsilanti 08/19/2019



**MUNRO**  
Real Estate & Development

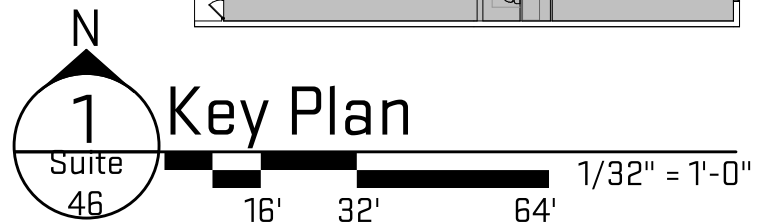
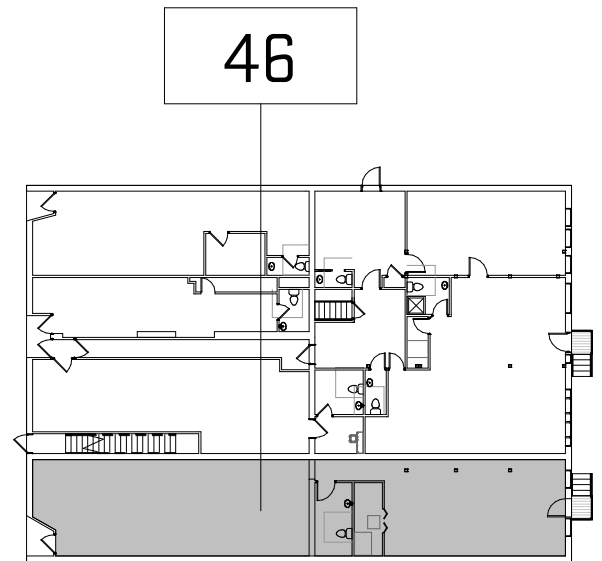
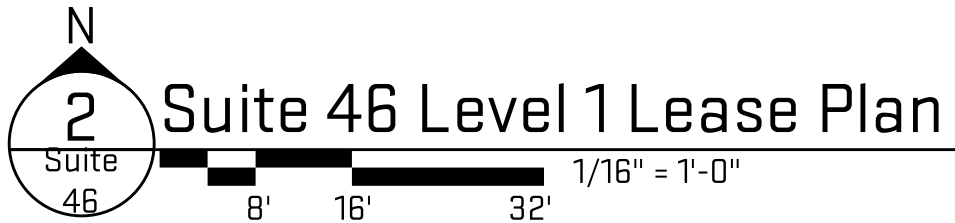
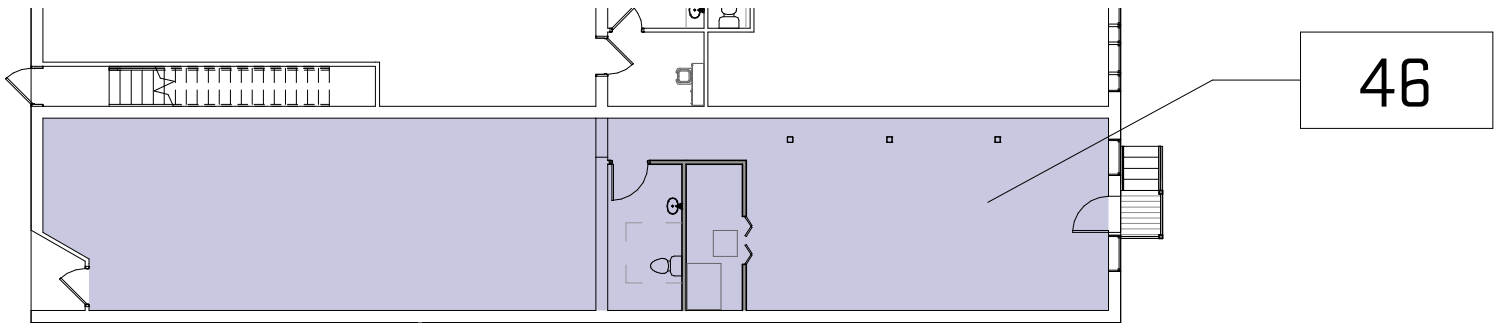

**FOR MORE INFORMATION CONTACT ALEX MUNRO**  
Real Estate Broker | 734.272.6612 | [awmunro@gmail.com](mailto:awmunro@gmail.com)

A LICENSED REAL ESTATE BROKER. ALL INFORMATION FURNISHED IS FROM SOURCES DEEMED RELIABLE. NO WARRANTY OR REPRESENTATION IS MADE AS TO THE ACCURACY THEREOF AND SAME IS SUBMITTED SUBJECT TO ERRORS, OMISSION OF PRICE, RENTAL, OR OTHER CONDITIONS, PRIOR TO SALE, LEASE OR FINANCING OR WITHDRAWAL

FOR LEASE

# Huron St. Building

Suite 50B 46-54 N. Huron St. Ypsilanti 08/19/2019



**MUNRO**  
Real Estate & Development

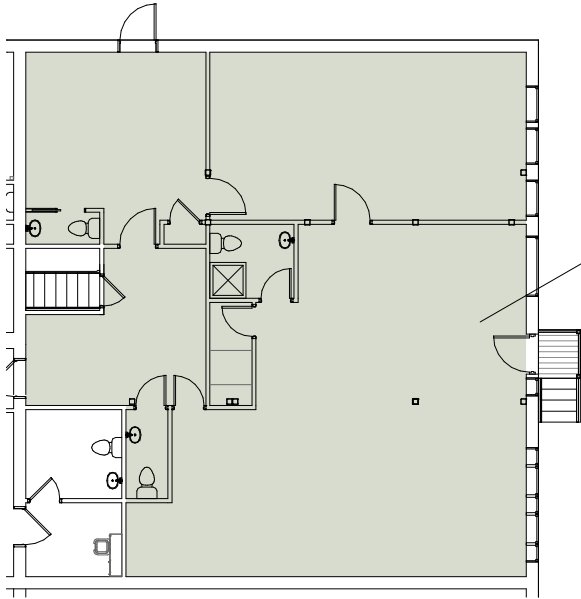

50B

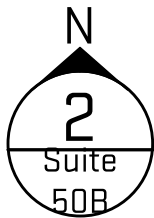

## Suite 50B Level 1 Lease Plan

8' 16' 32' 1/16" = 1'-0"

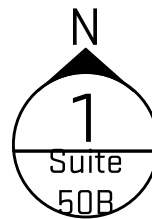
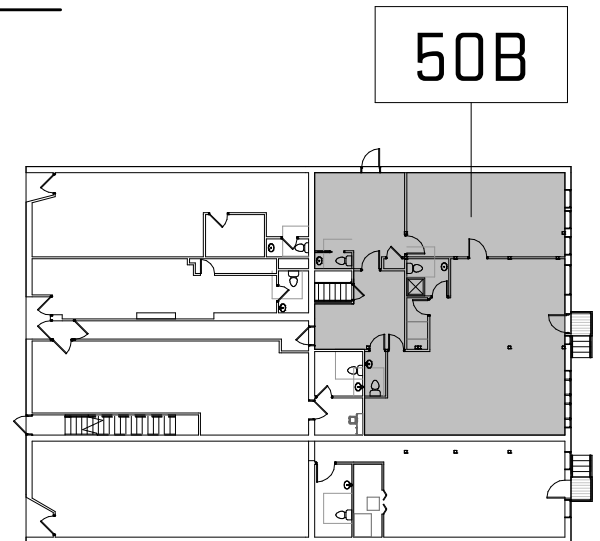

## Key Plan

16' 32' 64' 1/32" = 1'-0"

**FOR MORE INFORMATION CONTACT ALEX MUNRO**  
Real Estate Broker | 734.272.6612 | [awmunro@gmail.com](mailto:awmunro@gmail.com)

A LICENSED REAL ESTATE BROKER. ALL INFORMATION FURNISHED IS FROM SOURCES DEEMED RELIABLE. NO WARRANTY OR REPRESENTATION IS MADE AS TO THE ACCURACY THEREOF AND SAME IS SUBMITTED SUBJECT TO ERRORS, OMISSION OF PRICE, RENTAL, OR OTHER CONDITIONS, PRIOR TO SALE, LEASE OR FINANCING OR WITHDRAWAL

FOR LEASE

# Huron St. Building

Suite 52 46-54 N. Huron St. Ypsilanti 08/19/2019



**MUNRO**  
Real Estate & Development

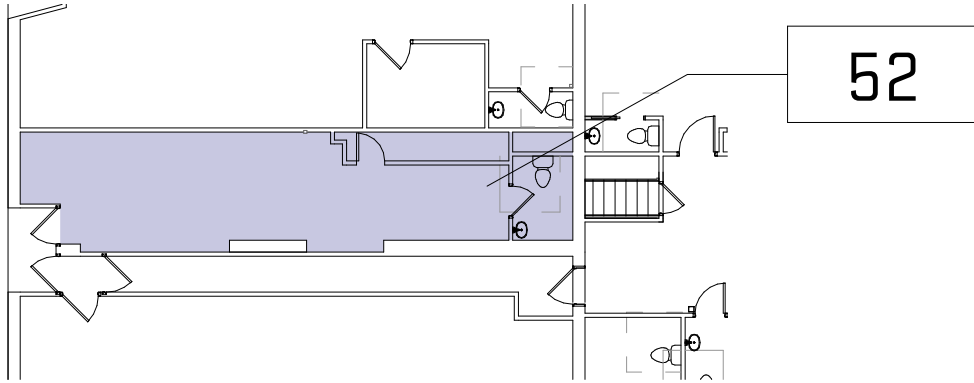

N

## 2 Suite 52 Level 1 Lease Plan

Suite  
52

8' 16' 32'

1/16" = 1'-0"

52

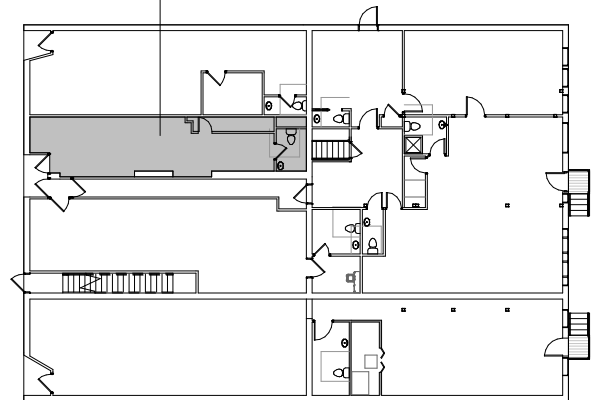

N

## 1 Key Plan

Suite  
52

16' 32' 64'

1/32" = 1'-0"

FOR MORE INFORMATION CONTACT ALEX MUNRO  
Real Estate Broker | 734.272.6612 | [awmunro@gmail.com](mailto:awmunro@gmail.com)

A LICENSED REAL ESTATE BROKER. ALL INFORMATION FURNISHED IS FROM SOURCES DEEMED RELIABLE. NO WARRANTY OR REPRESENTATION IS MADE AS TO THE ACCURACY THEREOF AND SAME IS SUBMITTED SUBJECT TO ERRORS, OMISSION OF PRICE, RENTAL, OR OTHER CONDITIONS, PRIOR TO SALE, LEASE OR FINANCING OR WITHDRAWAL